

8006 Six-Station AC Timer

Residential/Light Commercial Independent Program Irrigation Controllers

Installation, Programming and Operating Instructions

Features

- Operates six valves and master valve (or pump)
- Can operate two valves simultaneously
- Independent programming for each valve
- Operates 24 VAC valves
- Weekly or Cyclical program
- Up to four start times per day, per valve in weekly mode
- Station run time from 1 minute to 12 hours in 1 minute increments
- Watering Schedule 7-day weekly program or cyclical from once a day to once a month
- Sequential “manual” operation of all the valves via the irrigation controller
- Irrigation duration variable according to percentage value
- Simple, four button programming
- Optional manual operation
- Identifies short circuits, disconnects shorted valve, and gives visible alarm
- Operates off 120 VAC transformer
- Program backup with 9V battery
- Can be programmed under backup battery power, without AC power connection.

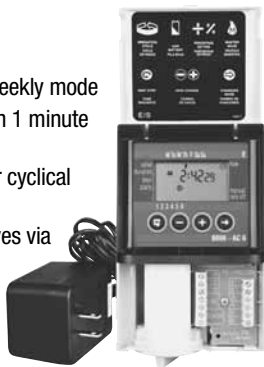

TABLE OF CONTENTS

INTRODUCTION	3
1. Specifications	3
2. Mounting Controller to Wall.....	3
3. Back-up Battery Installation	4
4. Connecting Valves and Transformer	4
5. Connecting a Master Valve or Pump Start Relay	5
6. Connecting a Rain Sensor	5
7. Programming the Controller	6
8. Setting Current Time and Day of the Week	6
9. Time Format (switching between AM/PM and 24 hour).....	7
10. Valve Selection	7
11. Programming Watering Time	7
12. Selecting Watering Days.....	8
Watering According to the Days of the Week	8
One-Time Irrigation	8
Cyclical Irrigation	9
13. Setting a Start Time	9
14. Setting a Start Time for Cyclical or One-Time Watering.....	10
15. Manual Operation	10
16. Sequential Manual Operation Via the Controller of All the Valves	11
17. Budget	11
18. "Rain Off" (Shutdown)	11
19. Valve In Operation	12
20. Valve is in Standby Mode (Wait)	12
21. No Power	12
22. Valve in Short Mode	13
23. Weak Backup Battery	13
24. No Program	14
25. Maintenance and Troubleshooting	14
26. Warranty	15
27. Technical Assistance	16

INTRODUCTION

THANK YOU for purchasing a DIG Model 8006 six station controller .

Please take the time to read through the enclosed instructions and follow them step by step. If you have any questions, please call our customer service line 1-800-344-6641.

1. SPECIFICATIONS

OPERATING SPECIFICATIONS

- Station run times: 1 minute to 12 hours in 1 minute increments
- Watering schedule: weekly or cyclical from 1 to 30 days
- Start time: 4 start times per day per valve
- Programs: Independent programming for each valve

ELECTRICAL SPECIFICATIONS

- Transformer input: 120 VAC, 60 Hz
- Station output: 24 VAC, 0.27 amps per station
- Maximum output: 24 VAC, 0.83 amps
- Battery backup: 9-volt alkaline battery (not included)

DIMENSIONS

- Height: 6" (15 cm) • Width: 4" (10 cm) • Depth: 2" (5 cm)

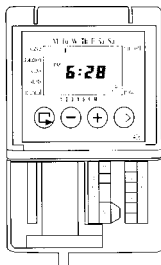

2. MOUNTING CONTROLLER TO WALL

- Select an indoor location near a 120 VAC outlet. The location should be protected from moisture and sunlight
- Remove the mounting bracket from the back of the controller
- Place the mounting bracket slightly below eye level. Secure the bracket with #5 or 6 x 1" screws (Note: If installing on drywall, install screw anchors)
- Align controller housing with mounting bracket and slide the controller down into position on the bracket.

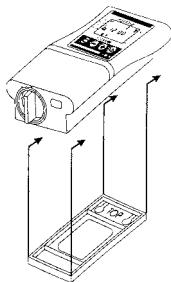

DO NOT PLUG TRANSFORMER INTO POWER SOURCE UNTIL THE CONTROLLER IS MOUNTED AND ALL VALVES HAVE BEEN CONNECTED.

3. BACK-UP BATTERY INSTALLATION

Rotate the battery compartment cover handle to the 11 o'clock position to remove the cover (see drawing). Install one 9-volt alkaline battery into terminal clip and insert into battery compartment and replace the cover. The controller display elements will briefly appear. When the display blinks "12:00", the controller is ready to program.

IMPORTANT: To replace the battery compartment cover, insert it with the handle in the "11" o'clock position to avoid possible cover guide pin breakage.

The battery is intended for irrigation program backup only. During electrical outages the program will not be erased, however, valves will not operate.

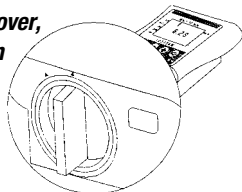

4. CONNECTING VALVES AND TRANSFORMER

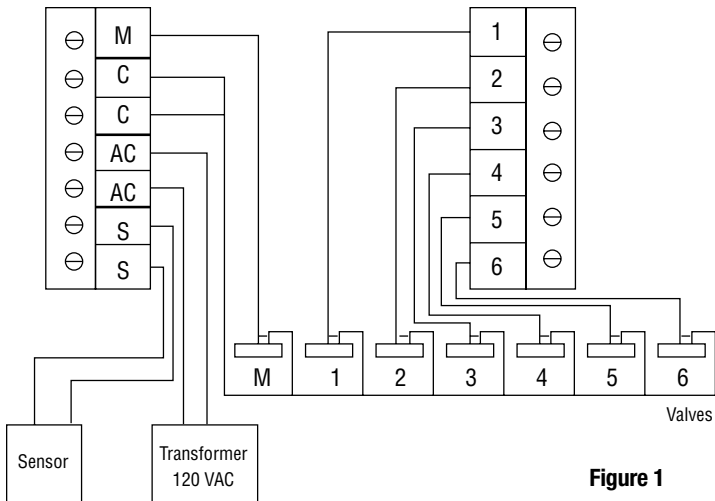

Figure 1

1. Install control wires from controller to valve(s) location. Recommended wire type is 18 gauge multi-strand color coded direct burial irrigation control wire.
2. Splice one of each valves solenoid wire to the white (common) wire by using waterproof wire connectors.
3. Splice each the remaining valve solenoid wires to a separate colored control wire by using waterproof wire connectors.
4. Remove lower faceplate from controller to access the terminal strip compartment.
5. Cut the control wires to length and strip the ends back about 1/4 in.
6. Secure the white (common) wire to the terminal(s) marked C by inserting wire in slot and tightening screw with small standard screwdriver.
7. Secure the color-coded station wires to numbered terminals by inserting wire in slot and tightening screw with small standard screwdriver.
8. Insert the two transformer wires into terminals labeled AC (polarity does not matter), and secure by tightening terminal screws with small standard screwdriver.

Do not plug AC transformer into power source before connecting transformer to controller.

5. CONNECTING A MASTER VALVE OR PUMP START RELAY

Mount the controller 10 to 15 feet away from the pump start relay and the pump.

NOTE: To operate a pump, a pump start relay must be used.

Connect either wire from pump start relay to controller terminal “M”, connect other wire to the “C” (common) terminal.

Do not connect controller directly to pump start, it can damage the controller.

Connecting the controller to a pump is to be performed by a qualified electrician only.





6. CONNECTING A RAIN SENSOR

An interrupt type, normally open rain sensor can be connected to the controller. The sensor connects directly to the controller sensor terminals.

Connect either wire from sensor to the two sensor terminals on the controller (see figure 1). Follow the sensor manufacturer’s instructions for calibrating the sensor.

7. PROGRAMMING THE CONTROLLER











DIG controllers are programmed with the aid of four buttons:

-  Programming step selector: Used to select the desired programming mode (included clock setting mode)
-  Data increment button (Decrease): Lowers the value of the selected parameter (e.g., when hours selected, from 06:00 to 05:00).
-  Data increment button (Increase): Raises the value of the selected parameter (e.g., when hours selected from 06:00 to 07:00).
-  Next step button: Used to select the parameter to be changed (hour, minute, etc.). Only a blinking parameter can be changed.



8. SETTING CURRENT TIME AND DAY OF THE WEEK

To enable the controller to operate the system at the correct times, the current time and current day of the week must first be set. Steps below explain how to set the day and time,

Press the  hour digit will blink. Use the  or , to set the current hour (note: use of AM and PM designations). Press  the minutes digit blink, set the current minute using  or . Press  A blinking arrow will appear in the upper portion of the display. Use the  or  to move the arrow to current day. Press  to proceed to the next step.

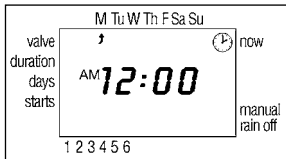

Note: If the last data entered stops flashing, press the  again to resume programming.

9. TIME FORMAT (SWITCHING BETWEEN AM/PM & 24 HOUR)

The default time format is AM/PM. There is also a 24 hour time format option that can be switched between the two formats.

Press several times until appears.

Press hour digit will blink. Press the and simultaneously. The clock reading switches from AM /PM to a 24 hour time display or vice versa.

Note: You can switch the time display format at any step in the programming process.

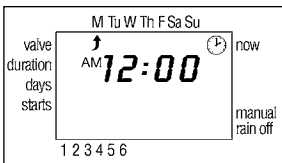

10. VALVE SELECTION

First select the desired valve, and then schedule as follows:

Press until appears.

Press . A blinking arrow appears at the bottom of the display. Move the arrow to the desired valve number by pressing or . Press to proceed to the next step.

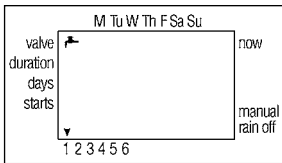

11. PROGRAMMING WATERING TIME

This setting determines the length of time that the valve will remain open.

Press until appears. Press , the hour digit blinks. Set the desired number of hours by pressing or . Press again, the minute digits blink. Set the desired number of minutes by pressing or . Press to proceed to the next step.

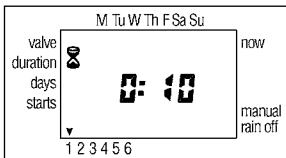

12. SELECTING WATERING DAYS

This setting determines which days the controller will operate. Choose either “A. Watering according to the days of the week” or “B. One-time irrigation or cyclical irrigation”.

Press until appears. Press , a blinking arrow appears at the top of the display, under Monday. At this stage you can set **one** of the following three options:

- A) Watering according to the days of the week
- B) One time only watering
- C) Cyclical watering

A. WATERING ACCORDING TO THE DAYS OF THE WEEK.

To select a watering according to the days of the week, move the blinking arrow to the desired day of the week by pressing . Press the . The arrow under the selected day stops blinking, and in a few seconds moves one position to the right, and blinks under the next day of the week. You can select additional days of the week in the same manner.

Press to proceed to the next step.

To cancel a scheduled watering day: Press and move the arrow under the selected day. Press under the selected day, the arrow will disappear and the blinking arrow will move one position to the right, and appear at the next day of the week. Cancel additional scheduled irrigation days in the same manner.

Press to proceed to the next step.

B. ONE-TIME IRRIGATION

This option is used to program the controller to operate the irrigation system one time only, for the irrigation period as set in watering time (durations).

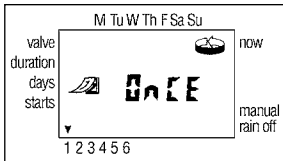
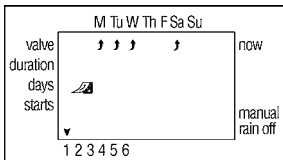

Press until appears. Press several times (for all the days of the week) until appears, and blinks on the display.

C. CYCLICAL IRRIGATION

This option is used to program the controller to operate the system in a cyclical manner. Once every 1-30 days, for the irrigation period and is followed by the one-time irrigation period.

Press until appears. Press several times (to advance all the days of the week) until appears, and blinks on the display. With the display blinking, press or . The number of days between watering appears on the display.

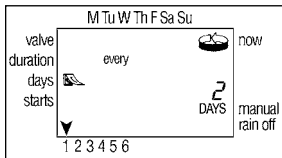

For example, if “every 30 days” appears, watering will take place once every thirty days, for the irrigation period as set in duration. To change the number of days press or .

Press to proceed to the next step.

13. SETTING A START TIME

In this step, up to 4 separate irrigation start times per valve can be programmed in the weekly mode (watering according to the days of the week).

Press until START I appears. The word OFF (or the last start time entered) appears. Press the word OFF blinks. Press or to set the desired start time hour (note AM and PM). Press the minute will blink. Press or to set the desired start time minute. Press to set START

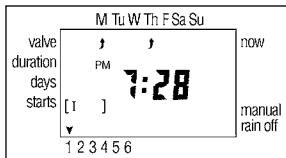

II and repeat the same steps for start times number 2, 3 and 4 as needed.

To cancel one of the start times select it by pressing . The hour digit blinks. Press the or until the word OFF appears. To program another valve, select the valve number and repeat the above steps.

14. SETTING A START TIME FOR A CYCLICAL OR ONE-TIME WATERING (WITH OPTION TO DELAY VALVE START TIME)

This program is used to pre-set the valve start time (only one start time available) and the number of days to delay the valve start time, the number of day(s) to delay option will appear on the display to the right of the irrigation start time above the word “days”.

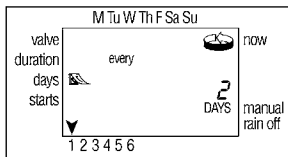

In this feature 0 days = program starts today; where 1 = program starts tomorrow, etc. (up to 30 days delay). Start time delay feature not available in specific days mode.

Press until START I appears or the last opening time entered appears on the display. Press . The hours and the AM/PM digits blink. Set the desired opening hour by pressing the or (note: AM and PM designations appear to the left of the hour digits). Press . The minute digits blink. Repeat the same step for setting the minutes and the number of days to delay watering (optional).

15. MANUAL OPERATION

Press the . The icon appears. Use and to open or close the valves.

- In this position, it is not possible to change the valve number. (In order to change the valve, you must return to the “valve” position.)
- If the controller is not connected to the main power supply, the word “AC OFF” will appear and the valve may not be opened.
- In manual operation, the valve will close automatically after the programmed watering time.

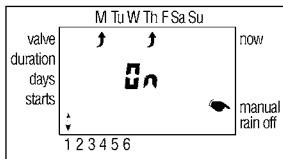
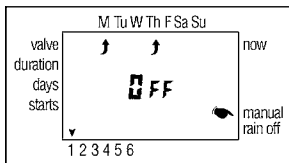

16. SEQUENTIAL MANUAL OPERATION VIA THE CONTROLLER OF ALL THE VALVES

This option allows all the valves to operate sequentially, one after the other (to select other valves please see Valve Selection #9 on page 4).

Press until appears, when no icon is blinking on the display, Press and hold down for 5 seconds. Valve number 1 will open and

operate for the programmed time. When valve number 1 closes, valve number 2 opens and so forth until the last valve has opened. All the valves designated to open will blink.

At any time you can influence the process pressing to close the current valve and open the next one

Important: You can only exit this screen after all the valves have opened

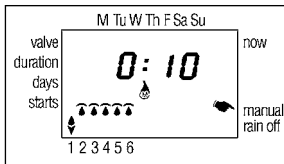

17. BUDGET

You can extend or shorten the time durations for all valves simultaneously by specifying a percentage increase or decrease for all the valves.

Press until appears, wait until no digit is blinking. Press simultaneously. 00+% is displayed. Press , the 00 blinks. Press or

to increase or decrease the percentage as necessary (in increments of 10% up to 90%). +% or -% are permanently display on the main display accordingly.

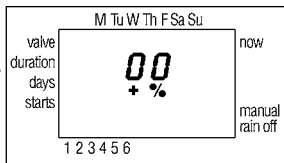

Important: Budget feature cannot be assigned to an individual valve. Budget will effect all stations equally.



18. "RAIN OFF" (SHUTDOWN)



This option is used to temporarily suspend the controller operation. The irrigation schedule remains stored in the controller memory, but is not implemented until the

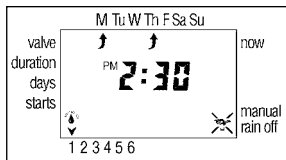

suspension is canceled. The suspension option disables all the valves connected to the controller.

In the current time mode, press & hold the minus button  until the rain-off icon  appears in the lower right corner of the display. To resume automatic operation, repeat the process – the icon will disappear.



19. VALVE IN OPERATION

The  icon will appear over the valve in operation. If the  flashes, the valve has not opened, the possibilities are:

- The valve is in standby mode (WAIT). The  icon will flash once every two seconds (30 times every minute).
- Valve is in “short mode”. The  icon will flash once every 1/2 second (120 times every minute).

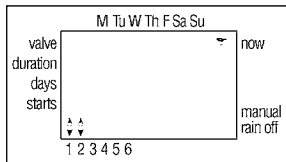

20. VALVE IS IN STANDBY MODE (WAIT)

When two valves are currently open, and a third valve is scheduled to open, the third valve enters wait mode. A blinking  appears above the number of the waiting valve. When one of the first two valves closes, the waiting valve opens. During “manual” operation of a waiting valve

via the irrigation controller,  appears on the display, and the valve will open the moment another valve closes.

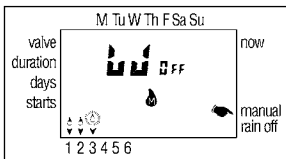

21. NO POWER

If for any reason, the controller does not receive electricity, a blinking  is displayed, indicating that the controller is not connected to the mains. The display of the icon is powered by the backup battery. The message AC OFF appears on a manual display when the irrigation controller attempts to execute an irrigation program or “manual” irrigation program performed via it, but does not receive voltage supply from the electrical mains.

The controller can be programmed in this state (no AC voltage), but valves cannot be opened.

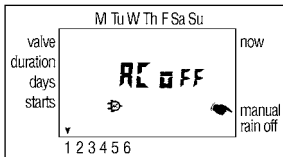

22. VALVE IN SHORT MODE

In the event of a short circuit in a valve or one of its connections, an  appears above the valve number and blinks every half a second (as distinguished from the Valve Wait mode described in Section 20). To check if the valve is indeed shorted, select the blinking valve on a “manual” screen (see Section 15).

If the valve is shorted, the word **Short** is displayed.

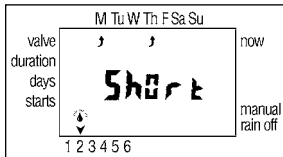

23. WEAK BACKUP BATTERY

When the battery is low, a  icon will appear on the display.

If the controller is not connected to the mains supply, the action of replacing the battery must be completed within 30 seconds to retain the programmed data.

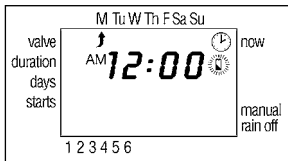

24. NO PROGRAM

During “manual” irrigation system operation via the irrigation controller, “no prog” appears on the display, meaning that no irrigation period has been set for the current valve. In this case, the irrigation controller “does not know” when to close the valve. In this situation valve opening is disabled.

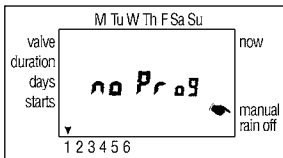

25. MAINTENANCE AND TROUBLESHOOTING

- Check the wiring on the controller’s terminal strip and on the valves, at the beginning of a new season.
- The battery should be removed if the irrigation controller will not be in use for a prolonged period.

PROBLEM: Valve does not open

CAUSE: One of the following not entered: Watering time, watering days, start time

SOLUTION: Check and program as required

CAUSE: Selector on “RAIN OFF” position

SOLUTION: Cancel RAIN OFF

CAUSE: No main electric power

SOLUTION: Check transformer and socket

CAUSE: Valve or connection faulty

SOLUTION: Check the valve or replace it

PROBLEM: Valve does not close

CAUSE: Dirt or stones in the valve.

SOLUTION: Clean the valve

CAUSE: Valve was opened manually

SOLUTION: Move to automatic position

CAUSE: Valve fault (torn diaphragm)

SOLUTION: Replace valve or part

PROBLEM: Display “disappears”

CAUSE: Backup batteries are dead and no power from the transformer

SOLUTION: Check the batteries and the transformer.

26. WARRANTY

DIG CORPORATION warrants these products to be free from defects in material and workmanship for a period of three years from date of purchase. This warranty does not cover damage resulting from accident, misuse, neglect, modification or improper installation. This warranty shall extend only to the original purchaser of the product for use by the purchaser. This warranty shall not cover batteries or any malfunction of the product due to battery failure.

The obligation of DIG CORPORATION under this warranty is limited to repairing or replacing at its factory this product which shall be returned to the factory within three years after the original purchase and which on examination is found to contain defects in material and workmanship. DIG CORPORATION SHALL IN NO

EVENT BE LIABLE FOR ANY INCIDENTAL OR CONSEQUENTIAL DAMAGES OF ANY KIND; THE SOLE OBLIGATION OF DIG BEING LIMITED TO REPAIR OR REPLACEMENT OF DEFECTIVE PRODUCTS. SOME STATES DO NOT ALLOW THE EXCLUSION OR LIMITATION OF INCIDENTAL OR CONSEQUENTIAL DAMAGES, SO THE ABOVE LIMITATION OR EXCLUSION MAY NOT APPLY TO YOU.

Unattended use for prolonged periods without inspection to verify proper operation is beyond the intended use of this product, and any damage resulting from such use shall not be the responsibility of DIG CORPORATION. There are no warranties, which extend beyond the description on the face hereof. In the case of purchase of the product for use other than, for irrigation purposes, DIG CORPORATION hereby disclaims any implied warranties including any warranties of merchantability and fitness for a particular purpose. In the case of the purchase of the product for personal, family or household purposes, DIG CORPORATION disclaims any such warranties to the extent permitted by law. To the extent that any such disclaimer or implied warranties shall be ineffectual, then any implied warranties shall be limited in duration to a period of three years from the date of the original purchase for use by the purchaser. Some states do not allow limitation on how long an implied warranty lasts, so the above limitation may not apply to you.

In order to obtain performance under this warranty, the unit must be returned to the factory, along with proof of purchase indicating original date of purchase, shipping prepaid, addressed as follows:

DIG CORPORATION, 1210 Activity Drive, Vista, CA 92081. Repaired or replaced units will be shipped prepaid to the name and address supplied with the unit returned under warranty. Allow four weeks for repairs and shipping time. Repair of damaged units not otherwise within warranty may be refused or done at a reasonable cost or charge at the option of DIG CORPORATION.

This warranty gives you specific legal rights, and you may also have other rights, which vary from state to state.

27. TECHNICAL ASSISTANCE

Should you encounter any problem(s) with this product or if you do not understand its many features, please refer to this instruction manual first. If further assistance is required, DIG offers the following customer support:

TECHNICAL SERVICE USA

- DIG's Technical Service Team is available to answer questions in English and Spanish from 8:00 AM to 5:00 PM (PST) Monday-Friday (except holidays) at 800-322-9146
- Questions in English and Spanish can be e-mailed to questions@digcorp.com or faxed to 760-727-0282
- Specification documents and manuals are available for downloading in English and Spanish at www.digcorp.com



1210 Activity Drive
Vista, CA 92081-8510, USA

Website:

www.digcorp.com

e-mail: dig@digcorp.com

011708 DIG CORP 26-038

Printed in the USA

DIG is a Registered Service Mark of DIG Corp.

